

# 09854 GATE FLOOR MIRROR - BRONZE MIRROR HEAVY AGED - METAL FRAME

## ASSEMBLY INSTRUCTIONS FOR MIRROR INSTALLATION

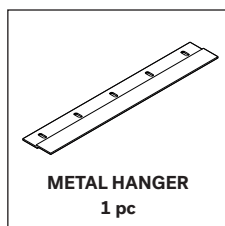

### HARDWARE ENCLOSED



### HARDWARE REQUIRED

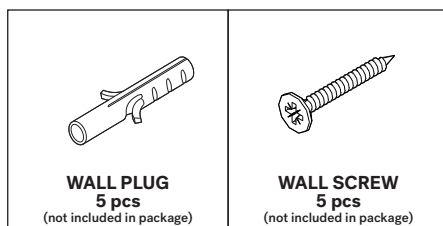

### TOOLS REQUIRED

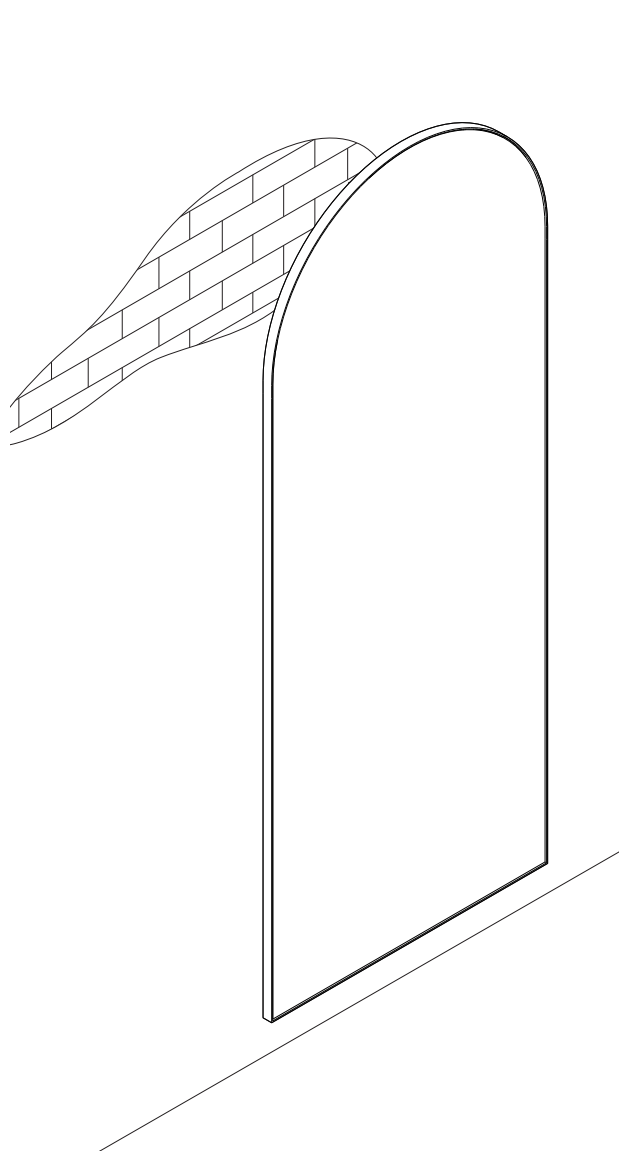
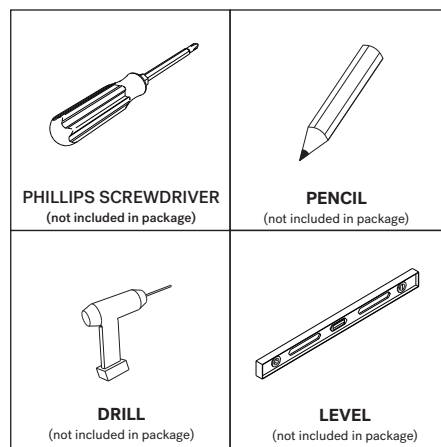

### NOTICE

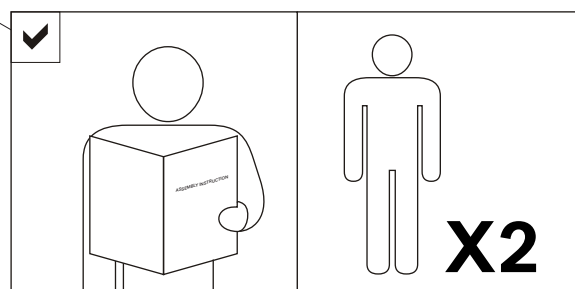

### SYMBOLS



DIRECTION

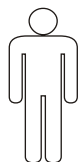

NUMBER OF PERSON NEEDED



USE HAND



USE DRILL

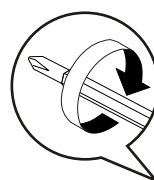

USE PHILLIPS SCREWDRIVER TO TIGHTEN



USE PENCIL

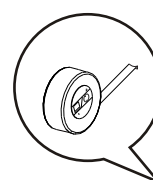

USE MEASURING TOOL

**1 INSTALLING METAL HANGER ON THE WALL**



AS WALL MATERIALS VARY, SCREWS FOR FIXING TO WALL ARE NOT INCLUDED. FOR ADVICE ON SUITABLE SCREW SYSTEMS, CONTACT YOUR LOCAL SPECIALISED DEALER.

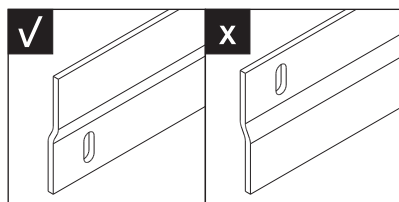
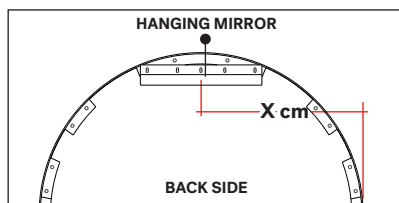
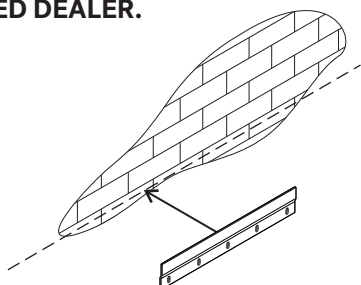

**Y cm**  
*(Desired height)*

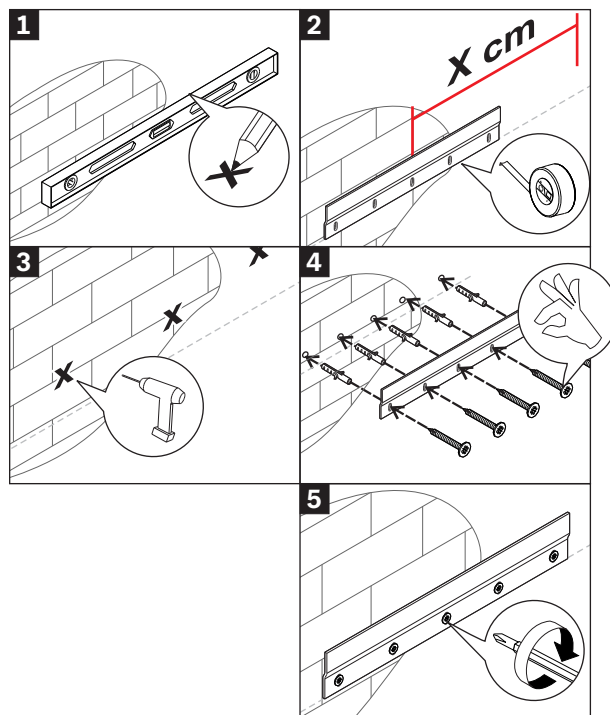

- USE METAL HANGER
- USE LEVEL FOR ALIGNMENT
- ILLUSTRATION WITH BRICK WALL

**2 HANGING MIRROR TO THE METAL HANGER**

