

**HARDWARE ENCLOSED**

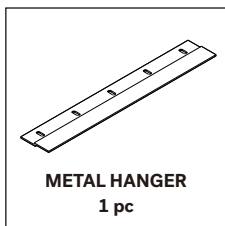

**HARDWARE REQUIRED**

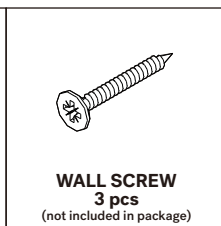
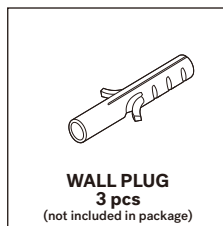

**TOOLS REQUIRED**

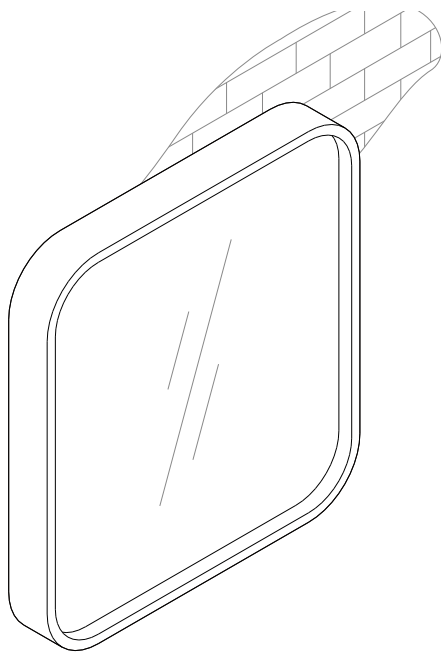
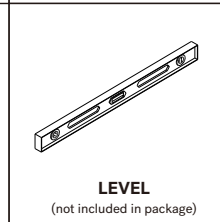
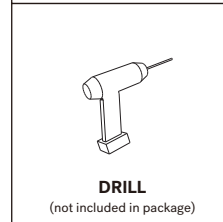
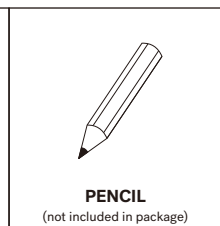
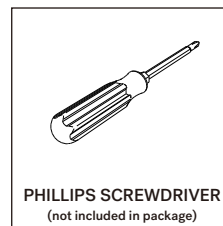

**NOTICE**

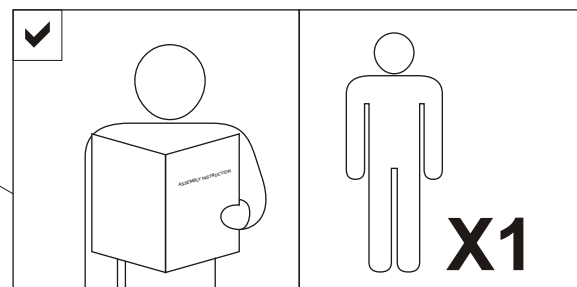

**SYMBOLS**



**DIRECTION**

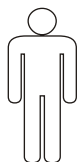

**NUMBER OF PERSON NEEDED**



**USE HAND**

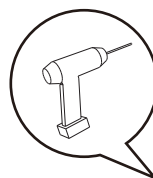

**USE DRILL**

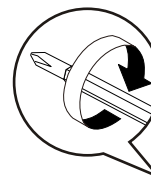

**USE PHILLIPS SCREWDRIVER TO TIGHTEN**



**USE PENCIL**

**1** INSTALLING METAL HANGER ON THE WALL



AS WALL MATERIALS VARY, SCREWS FOR FIXING TO WALL ARE NOT INCLUDED. FOR ADVICE ON SUITABLE SCREW SYSTEMS, CONTACT YOUR LOCAL SPECIALISED DEALER.

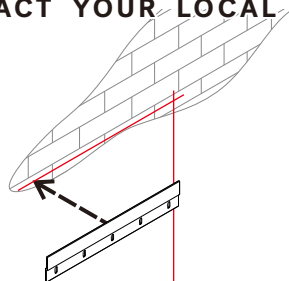

**Y cm**  
(Desired height)

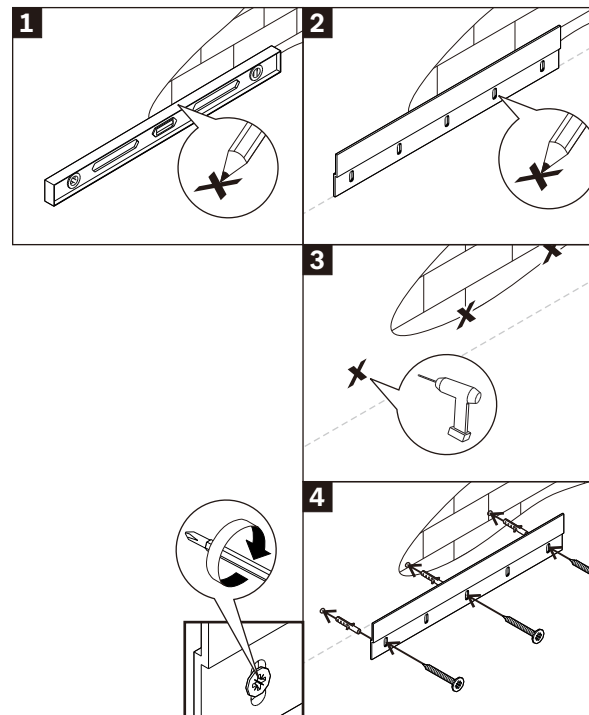
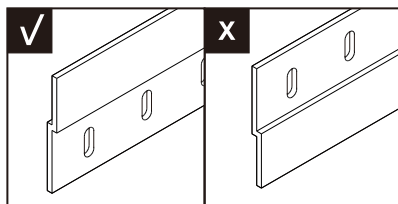

- USE METAL HANGER
- USE LEVEL FOR ALIGNMENT
- ILLUSTRATION WITH BRICK WALL

**2** INSTALLING MIRROR ON THE WALL

