

HARDWARE ENCLOSED

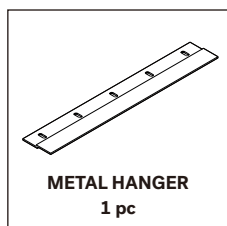

HARDWARE REQUIRED

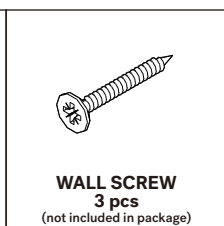
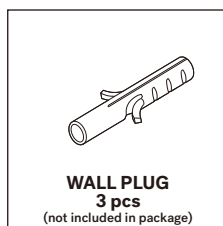

TOOLS REQUIRED

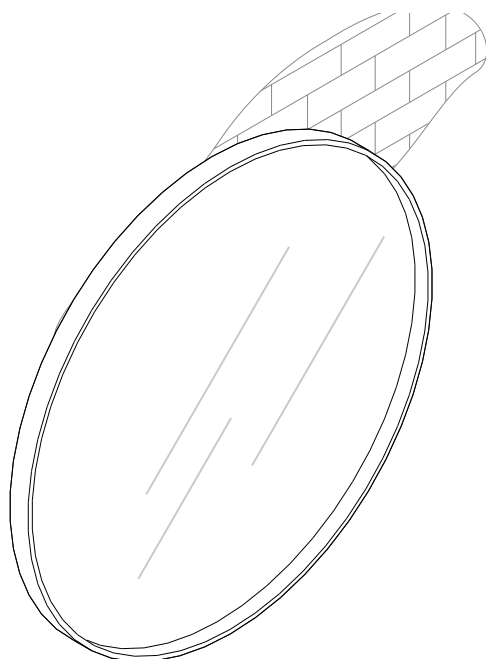
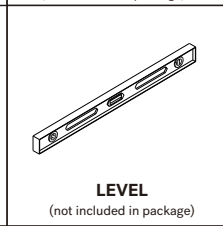
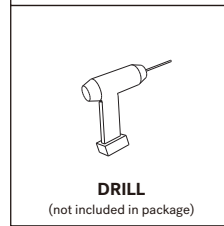
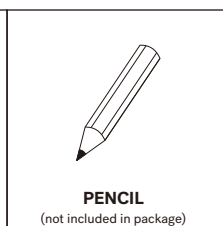
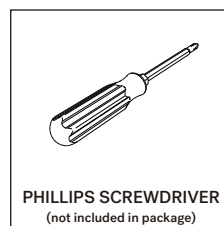

NOTICE

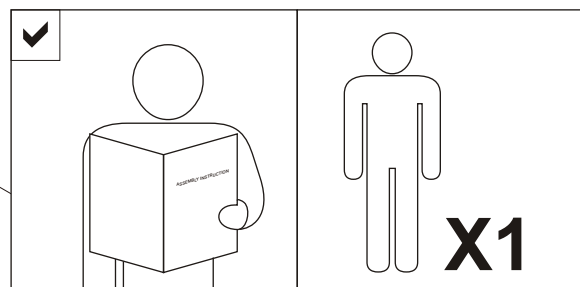

SYMBOLS



DIRECTION

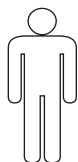

NUMBER OF PERSON NEEDED



USE HAND

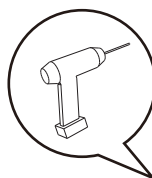

USE DRILL

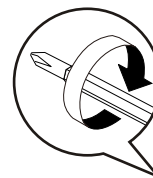

USE PHILLIPS SCREWDRIVER TO TIGHTEN



USE PENCIL

1 INSTALLING METAL HANGER ON THE WALL



AS WALL MATERIALS VARY, SCREWS FOR FIXING TO WALL ARE NOT INCLUDED. FOR ADVICE ON SUITABLE SCREW SYSTEMS, CONTACT YOUR LOCAL SPECIALISED DEALER.

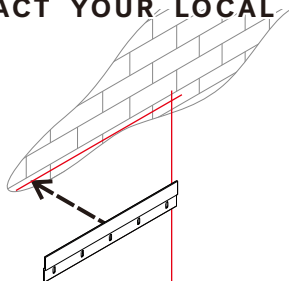

Y cm
(Desired height)

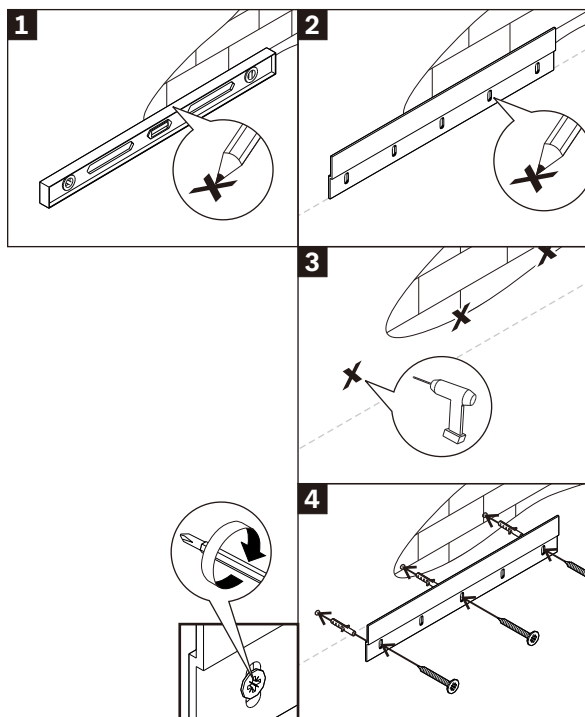
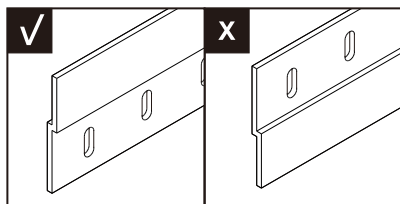

- USE METAL HANGER
- USE LEVEL FOR ALIGNMENT
- ILLUSTRATION WITH BRICK WALL

2 INSTALLING MIRROR ON THE WALL

